

Used in Various Situation PC Microscope DS-3UX-3 Series

micro

Micro Square

For quality inspection, for research and development, and at the manufacturing site
-the ultimate in cost performance

2M pixel clear image, magnify x1 to x220 , Make adjustable the LED light power,
Measuring software is standard

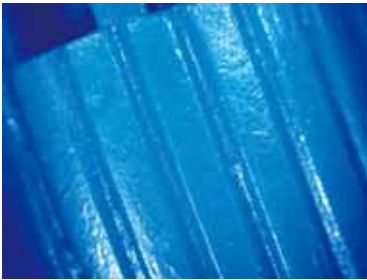

● Standard measuring software



Point to point length

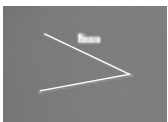

3 point angle

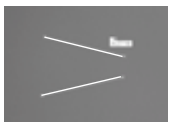

2 line angle



Circle



Rectangle



Distance between 2 line



Text



Calibration

scale

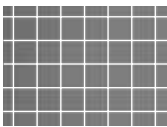

Grid

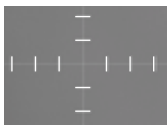

Close line scale



Circle scale



Split Vertically



Split Horizontally



Excel transfer

PC Circumstances

Usable PCs : 100% compatible
DOS/V, AT machines with
USB2.0 interface
CPU: More than Pentium III
2.8Ghz
Memory: More than 512MB
OS: Windows XP, 2000 SP4

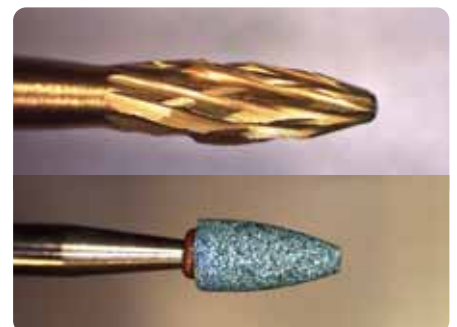

● Magnification data

	DS-3UX-III	DS-3UXL-III
Magnification	1x – 220x	1x – 120x
WD = Distance between the microscope and the work (mm).		
Visual Range Indication	Work Distance (approx.)	Work Distance (approx.)
25 x 33 mm		132 mm
10 x 13	30mm	
7 x 9.3		42
4 x 5.3	11.5	27
3 x 4		22.5
2.5 x 3.3	6.5	19.5
2 x 2.7	5	17
1.7 x 2.3	4	
1.5 x 2	3.5	
1.3 x 1.7	2.5	

● Option



DS-XYX stand



DSMstand25



Flexible stand S-20



Tilt stand CS-001



MS-BL-01

● Specifications

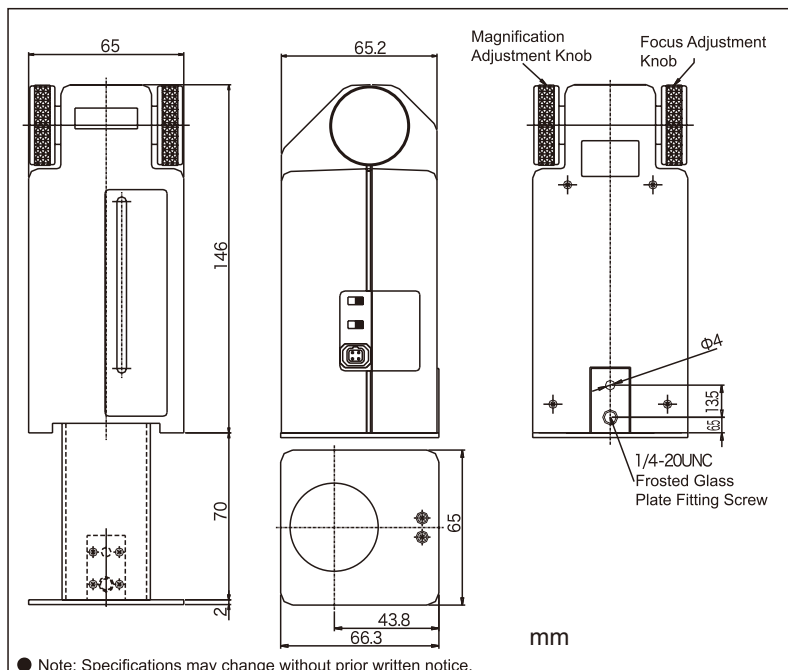

Micro Square

Micro Square Co., Ltd.

6F, 3rd Taka BLDG.3-13-15 Sagamiono
Sagamihara city Kanagawa Pref. Japan
POST CODE 228-0803

Phone: +81-42-705-5501

Fax : +81-42-705-5503

URL : <http://www.microsq.com/>

E-mail : webmaster@microsq.com

■ Direct inquiries to: